



coatmaster

measure up. contactless.

Coatmaster Flex User Manual



flex.coatmaster.com

Version: 11-2019



coatmaster AG
Flugplatzstrasse 5
CH-8404 Winterthur
SWITZERLAND



+41 (0) 52 212 02 77



info@coatmaster.com



www.coatmaster.com



+41 (0) 52 511 83 11

© 2019 coatmaster AG

Distribution and duplication of this document, and utilisation and communication of its contents other than for legitimate purposes, are not permitted without the express permission of coatmaster AG. Violations will result in legal action. All rights are reserved in the event of patent grant or utility model registration (ISO 16016).

Subject to technical changes and printing errors, the values given are approximate and are not to be understood as legally warranted characteristics. These values may vary according to component tolerance.

Last update: 09/2019

Table of contents

1	Technical Data.....	3
2	Customer Requirements and Device Specification	4
3	Applications.....	5
4	Functionality and Measuring Principle.....	6
5	Safety and Responsibility	7
5.1	Warning Symbols.....	7
5.2	Signs and Icons	8
5.2	Intended Use.....	8
5.3	Improper Use	9
5.4	Product Safety.....	10
6	Delivery Scope	11
7	Set-Up	12
7.1	Battery.....	12
7.2	Router.....	14
7.3	Navigation Panel	15
7.4	Turning the Power On/Off.....	15
7.5	Language Selection.....	15
7.6	Wi-Fi Settings.....	16
7.7	Activation.....	17
8	Operating Instructions.....	18
8.1	System Settings	18
8.2	Main Menu.....	21
8.3	Block Menu.....	22
8.4	Application Menu	23
8.5	Measurement	31
8.6	Data Transfer/Cloud	32
9	Troubleshooting and Best Practice	36
9.1	Error Messages	36
9.2	Error Codes	37
9.3	Frequently Asked Questions (FAQs).....	38
9.4	Hotline.....	38
10	Storage and Transportation.....	39
11	Maintenance and Repair	39
11.1	Replacement of the Inlet Filter.....	40
11.2	Replacement of the Front Glass	41
11.3	Cleaning and Care.....	41
11.4	Warranty.....	41

Foreword

Dear Customer,

With the purchase of a coatmaster® Flex, you have acquired a high-quality, precise product. To help you to work successfully and productively with this device for many years, in this manual we provide you with some instructions for use. coatmaster AG has made every effort to manufacture a safe and high-quality device that complies with all applicable regulations. Our strict quality control procedures ensure high quality standards even for high volume production. Please add your own and treat the device with care. Should you have any questions regarding the use of the equipment, please do not hesitate to contact us.

We wish you success and 'a perfect coating'.

Reinhard K. Stary
coatmaster AG



1 Technical Data

Characteristics	Tolerance/ Description
Measuring distance range	20-150 mm
Measurement angle / tolerance	±70°
Measuring point size	2 mm ² at 50 mm distance
Measuring range thickness	1–1,000 µm (depending on coating type)
Standard deviation	< 1% of the thickness ¹
Measuring time	300 ms
Storage conditions	-10–50°C max. 80% humidity (non-condensing)
Power supply	Bosch Professional Lithium-Ion battery GBA 18V 3.0 Ah
Number of measurements	Up to 1,000 measurements per battery charge
Operating conditions	Temperature: 0–35°C, rel. humidity: 10%-75%
Weight (without battery)	1.3 kg
Dimensions	374 x 91 x 203 mm
IP protection type	IP20

Table 1: Technical data



2 Customer Requirements and Device Specification

Measuring the coating thickness early in the process is the key to documenting and controlling in-line coating processes, saving on coating material, improving coating quality, and reducing running-in time and scrap. Coating processes are highly sensitive to changes in environmental conditions; therefore, it is crucial to have access to a thickness gauge that is easy to handle and works in an industrial environment.

The patented measurement process used by the coatmaster® Flex is non-contact (as opposed to systems based on magnetic induction or ultrasound) and non-destructive. It can therefore be applied on wet, powder, and cured coatings, independently of the coating material, thickness, or colour (including white). In contrast to magnetic induction-based systems, the Flex device permits measurement of coating thickness on substrates such as metal, wood, plastic, and rubber. Unlike photothermal, laser-based, and ultrasound systems, it is a reliable, light, user-friendly, safe, cost-effective, precise, and accurate measurement system. It requires minimal calibration and is insensitive to the angle and distance of measurement.

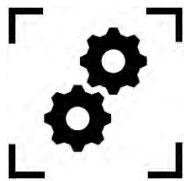



3 Applications

The coatmaster® Flex is a flexible and robust handheld device for non-contact measurement of coatings.

The coatmaster® Flex is unique and versatile and can be used in a wide variety of industries and industrial sectors:

- Automotive
- Rail
- Aerospace
- Marine
- Construction
- Furniture
- Turbines
- Wind Power
- Pipelines
- Medical/Technical

The coatmaster® Flex is particularly suitable for the following applications:

Powder paints	
	Due to precise control of coating thickness, up to 30% of the powder quantity can be saved. Measurement early in the process saves time and reduces rejection rates.
Wet paints	
	Precise measurements are possible even before drying. The measuring equipment capability is guaranteed. This saves material and time, and ensures quality.
Coil coating	
	The coatmaster® brings the coating process for coils into the target range after only a few metres. Savings of coil and coating material pay for themselves within a few months.

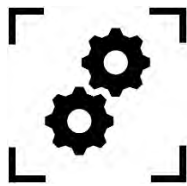

4 Functionality and Measuring Principle

The coatmaster® works according to the principle of thermal layer testing (TLT). The surface of the coating is heated with a light pulse. After brief heating by a few degrees Celsius, the surface is cooled by heat conduction to deeper areas of the coating and the substrate. The cooling process on the surface depends on the thermal properties of the coating and the substrate. The thinner the coating, the faster the surface temperature decreases, providing it has a lower thermal conductivity than the substrate. The thickness and thermal properties of the coating are derived from the dynamics of the surface temperature.

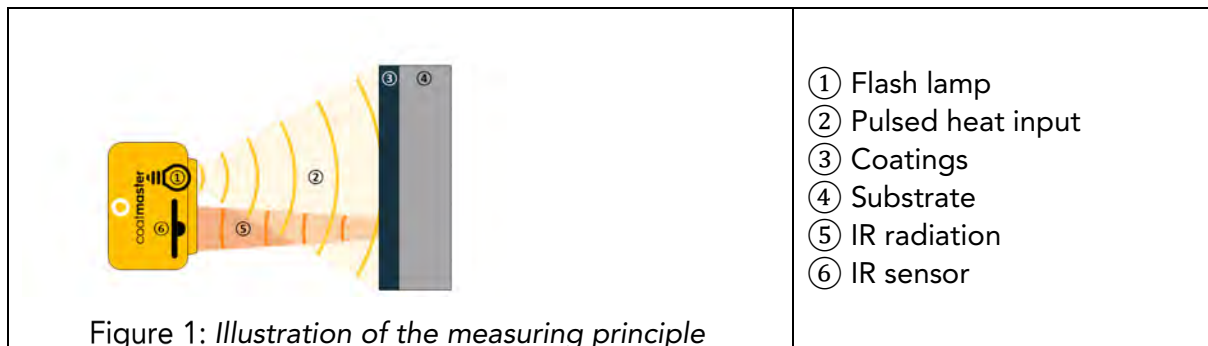

Generally, coatings have a very irregular surface. Powder coatings before curing have an even rougher surface, but can nevertheless be measured with the coatmaster® Flex. The properties of this roughness are influenced by various factors, such as pre-treatment, the type and roughness of the substrate, the type of coating (e.g. particle size, distribution, and chemical composition), and the exact conditions (temperature distribution, baking time) during baking. The figure below shows a microscopic sketch of this roughness. The TLT automatically compensates for the roughness described above, using an optical averaging process. This allows a reliable determination of the coating thickness, even with changing parameters.

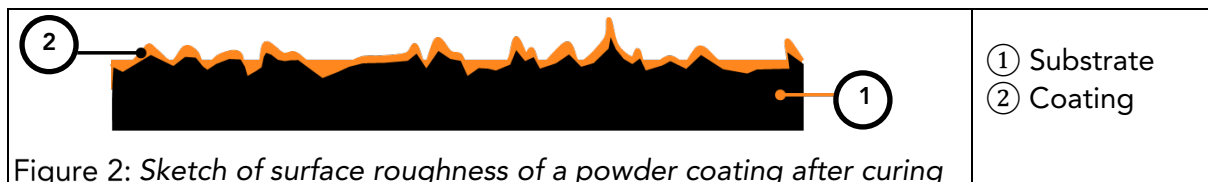



5 Safety and Responsibility

This section provides an overview of all relevant safety features for optimum personal protection and safe and trouble-free operation. Keep the operating instructions with the safety instructions so that you can refer to them later.

5.1 Warning Symbols

For your safety, it is important to read and fully understand the following table showing the different warning signs and their definitions!







Symbol	Definition
 DANGER	Warning of an immediate danger that, if not avoided, will result in death or very serious injury. ◇ Measures to avoid the danger.
 WARNING	Warning of an immediate danger that, if not avoided, will result in serious injury. ◇ Measures to avoid the danger.
 CAUTION	Indication of a hazardous situation that, if not avoided, may result in minor or moderate injury. ◇ Measures to avoid the situation.
	Warning of optical radiation.
	Warning of electrical voltage.
	Warning of hazards associated with charging batteries.
CAUTION	Indication of a hazardous situation that, if not avoided, may result in property damage; however, no action is required with regard to personal injury. ◇ Measures to avoid the damage.

Table 2: Warning symbols

5.2 Signs and Icons



Symbol	Definition
	This symbol means that your device meets the safety requirements of all applicable EU directives.
	This symbol means that you may only dispose the device at an approved local disposal site.
	Information: a highlight containing particularly important information for better understanding.

Table 3: Signs and icons

5.2 Intended Use

The coatmaster® Flex is intended exclusively for the measurement of coating thicknesses.

The device should only be used as a handheld device.

The device should not be mounted on a robot or fixture, or operated for an extended period of time.

The instrument may only be operated and cleaned by trained personnel. The intended use also includes compliance with these instructions and the maintenance intervals must be observed.

Have your device repaired only by qualified personnel and only with original spare parts. This ensures that the safety of the device is maintained.

The device is not approved for operation in environments with potentially explosive atmospheres.

Keep the device away from rain or moisture. Penetration of water into an electrical appliance increases the risk of electric shock. Do not place the measurement device in a place where components could come into contact with corrosive gases or salty air.

Do not block ventilation openings. The ventilation openings prevent the interior of the unit from overheating.

Remove the battery before cleaning. Do not use solvents for cleaning, to avoid damaging the housing surface. Use a clean, dry cloth.

In accordance with Directive 2012/19/EU, please take old parts to the appropriate recycling facilities for proper disposal, reprocessing, and reuse. Never throw electrical equipment into the household waste! By properly disposing of the electrical appliances, you help to protect valuable resources and prevent possible negative effects on health and the environment, which could otherwise occur due to improper waste disposal. Accessories and packaging should also be recycled in an environmentally-friendly manner.

5.3 Improper Use

Use not mentioned above, or use that does not comply with the technical specifications, is considered to be improper use. The operator is solely responsible for any damage caused by improper use.

The following applications are prohibited:

- Use of the equipment in environments where liquids may get into the device.
- Introduction of any objects into the coatmaster® Flex or similar devices.
- Opening of the device, except for cleaning or changing filters and changing the plexiglass pane. This only applies when the battery is not in place. Opening the device, other than for standard maintenance operations (see section 11), voids the warranty and the manufacturer assumes no liability.

The following safety instructions point out dangers of a general nature that may occur when handling the device. The user must observe all the instructions listed in order to minimise possible hazards.

Additional warning messages can be found in this manual whenever the actions described could result in hazards.



Symbol	Description
	<div style="text-align: center;">  </div> <p>WARNING</p> <p>Integrated light source.</p> <p>The coatmaster® Flex contains a 125Ws Xenon flash lamp, which falls under risk group 3 according to the photobiological safety standards of IEC 62471:2006. The coatmaster® does not emit harmful UV radiation.</p> <p>When pressing the trigger button to conduct a measurement, a flash – comparable to a studio flash – is released. Hazardous optical radiation could be emitted in circumstances of direct and close eye contact. Visual impairment or eye injury may result.</p> <ul style="list-style-type: none"> ◇ Never look directly into the light source. ◇ Never point the light source towards a person in the near vicinity. ◇ For the use of the coatmaster® Flex in an operating process environment, we recommend establishing protective measures (e.g. opaque cover) to limit any risk of direct exposure to the flashlight. ◇ Use the coatmaster® in a well-lit environment.
<p>CAUTION</p> <p>Device damage may occur if the battery is changed during operation.</p> <p>Never change the battery during operation, as this can lead to the device being damaged.</p> <ul style="list-style-type: none"> ◇ Always switch off the device before changing the battery.  	

Table 4: Warning – improper use

5.4 Product Safety

The measuring device has been designed and built with the latest state-of-the-art technology; however, risks to users, property, and the environment may arise if the measurement device is used carelessly or improperly, for which coatmaster AG bears no responsibility.

coatmaster AG has identified the following residual risks from the device:

- The device is operated by inadequately trained personnel.
- The device is not being operated in compliance with the instructions.

Warnings in this manual are intended to alert the user to these remaining hazards.

The equipment has been tested in accordance with the safety requirements for electrical equipment for measurement, control, and laboratory use (IEC 61010-1:2010) and the Low Voltage Directive 2014/35/EU.

To ensure photobiological safety, the device must be operated in accordance with the guidelines for the safe use of high intensity pulsed light sources on humans (IEC 62471:2006).

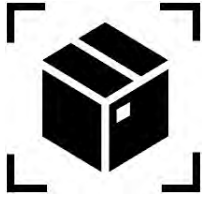

6 Delivery Scope

The coatmaster® Flex is delivered with the following components in a robust transport case:



Figure 3: Delivery inclusions

- Ⓐ coatmaster® Flex
- Ⓑ Router (optional)
- Ⓒ Power supply router (optional)
- Ⓓ Rechargeable battery 18V Bosch (2x)
- Ⓔ Battery charger
- Ⓕ Transport case

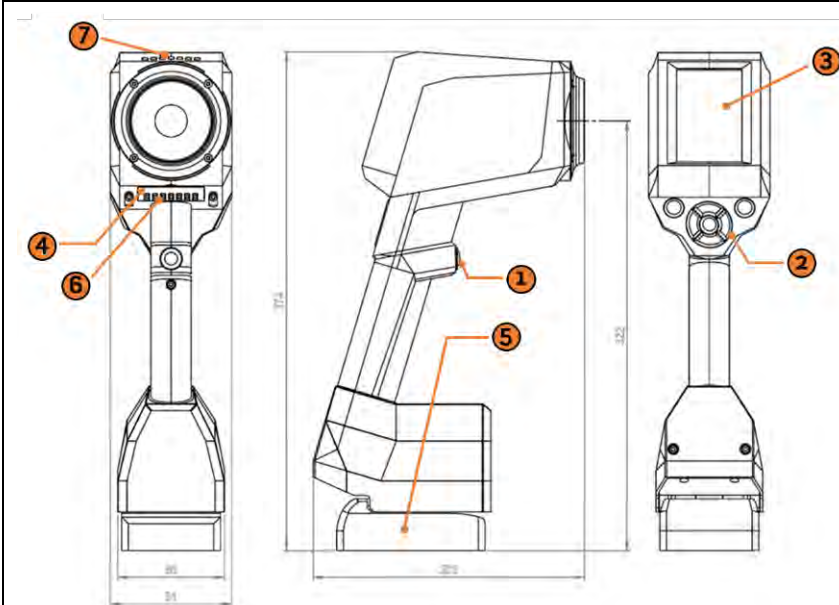

Figure 4: Overview of dimensions and components

- ① Trigger button
- ② Input panel
- ③ Display
- ④ Filter cover
- ⑤ Removable battery
- ⑥ Air intake
- ⑦ Air outlet



If the battery becomes defective, liquid can escape. Avoid contact. If contact accidentally occurs, flush with water. If liquid comes into contact with the eyes, also seek medical help. Liquid ejected from the battery may cause irritation or burns.

If the battery becomes defective, escaping liquid may come into contact with adjacent components. Check any concerned parts. Clean such parts or replace them, if required.

7.1.2 Battery Installation

Push the fully charged battery into the designated holder at the bottom of the device until it snaps into place.



Ensure that the red tab is completely engaged.



Figure 7: Battery installation

7.2 Router

Router installation and connection is only necessary if you do not use a local Wi-Fi network!

7.2.1 Router Installation

If you choose to connect the device with the coatmaster® router, screw all 3 antennae tightly onto the router (Figure 8: Installation of antennae to the router).

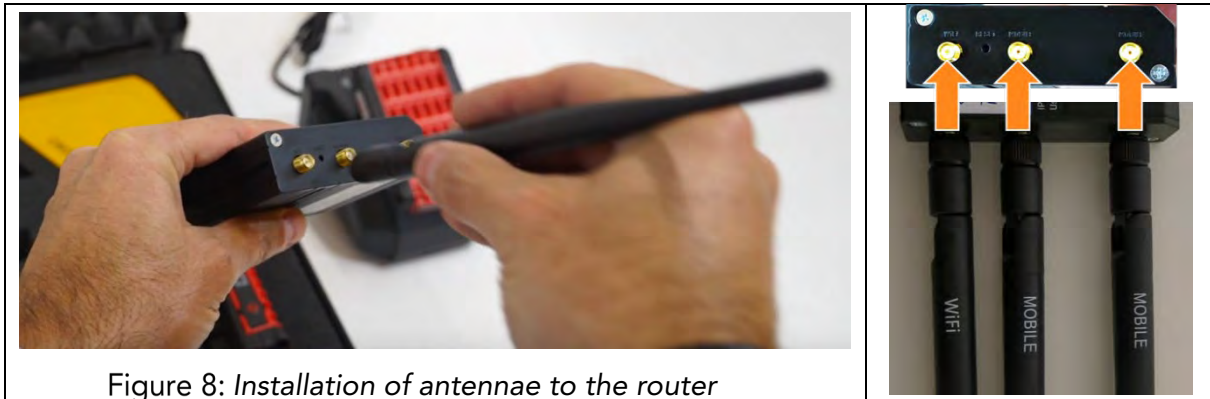

Figure 8: Installation of antennae to the router

- ⓘ Ensure that all the antennae are correctly connected: Wi-Fi antenna to Wi-Fi socket and mobile antennae to mobile sockets!

7.2.2 Router Connection

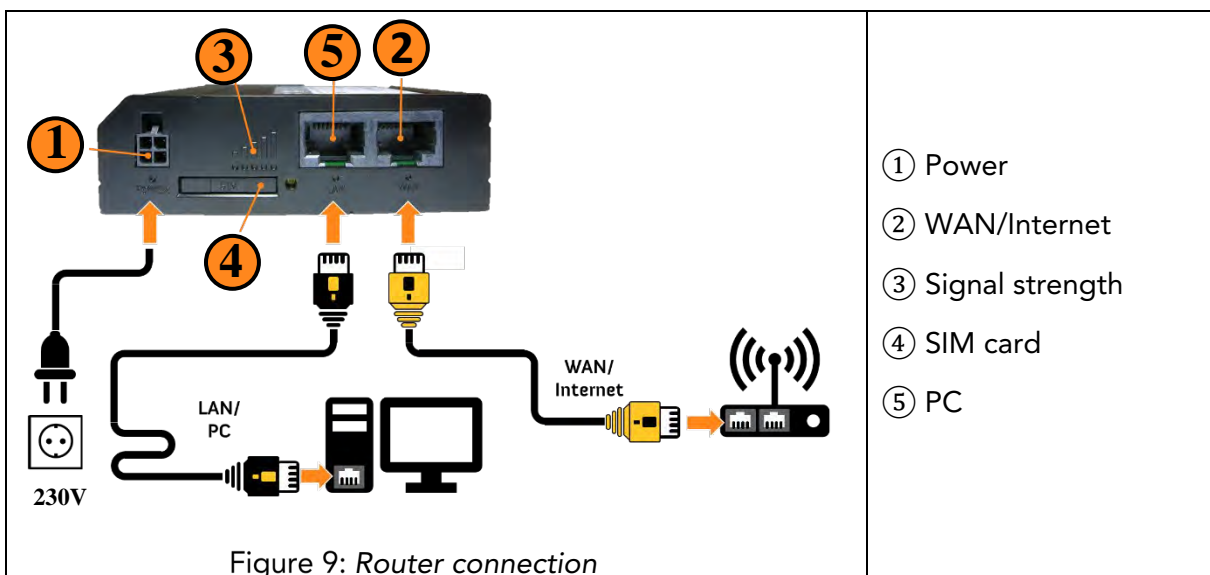

Figure 9: Router connection

Connect the Router via a LAN/Ethernet cable to the Internet or your local WAN system, as shown in Figure 9: Router connection. Plug in the power cable.

- ⓘ It takes about two minutes for the router to boot up.
- ⓘ Check the LEDs ③ to see the status of the signal strength.

7.3 Navigation Panel

Figure 10: Input panel - keys and elements shows an overview of the most important elements for navigating the menus.

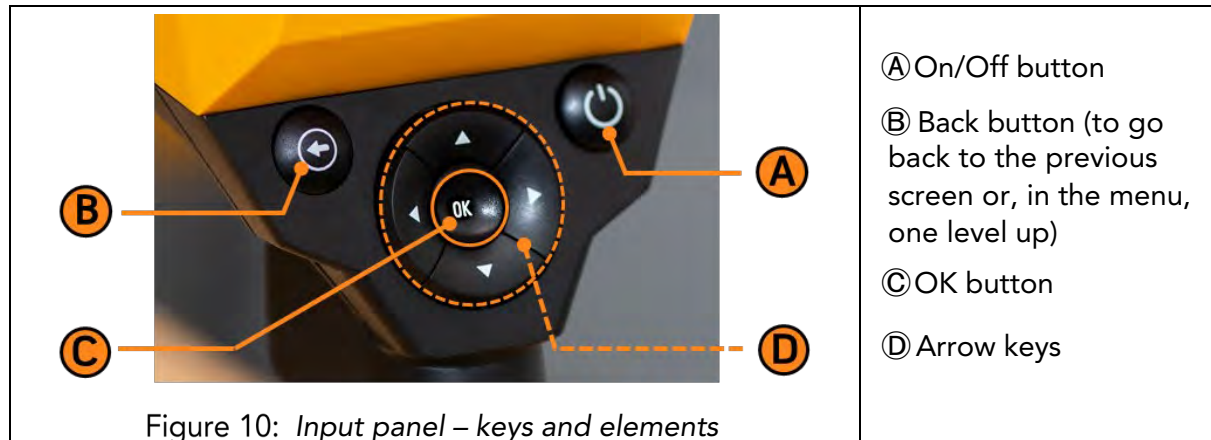

7.4 Turning the Power On/Off

i After you have optionally connected and turned on the router, and the charged battery is connected, turn on the unit by pressing the On/Off button Ⓐ in the input panel (see Figure 10: Input panel - keys and elements).

It takes about 40 seconds for the coatmaster® Flex to boot up. To see the time until your coatmaster® Flex is fully operational, view the boot window on the coatmaster® Flex screen; the boot indicator scale is shown in the display.

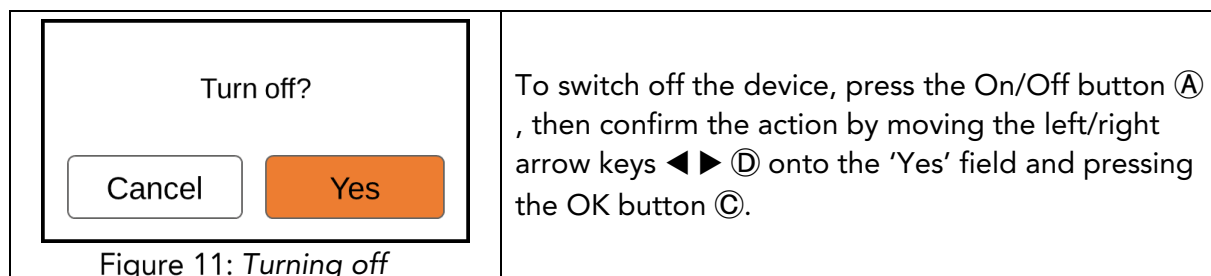

CAUTION Do not remove the battery to turn off the device!

i The device can be forced to shut down when the On/Off button is pressed for more than seven seconds. With this shortcut procedure, a 'Yes' confirmation is not necessary.

7.5 Language Selection

After switching on the coatmaster® Flex, you will be directed to the language selection menu (see Figure 12: Language selection).

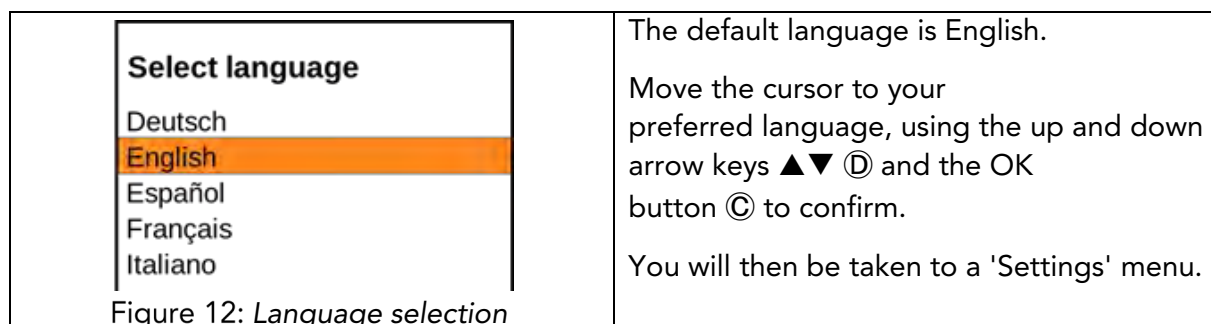

7.6 Wi-Fi Settings

Wi-Fi settings are only necessary if you do not use the supplied coatmaster® router!

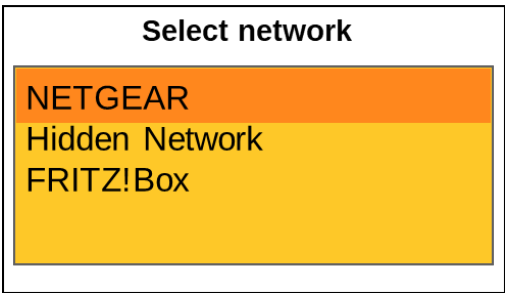







Figure 13: Wi-Fi Settings

The Wi-Fi symbol in the status line indicates the strength of the Wi-Fi signal:

high
medium
low
none

When starting the coatmaster® Flex for the first time, it will automatically connect to the coatmaster® router, if available. If not, after language selection, the device opens the Wi-Fi network submenu so that you can select the network you wish to connect to.

Choose your local Wi-Fi network in the list using the up/down arrow keys ▼▲Ⓓ and the OK button Ⓒ to validate.

To enter the password for your local Wi-Fi network, use the arrow keys Ⓓ to navigate the keyboard and press the OK button Ⓒ to confirm the characters (see Figure 10: Input panel - keys and elements).

During the connection period, the following message in the status field appears:



When the Wi-Fi connection is successfully established, you must confirm using the OK button Ⓒ



i If you have conducted a factory reset and need to re-activate your coatmaster® Flex, the Wi-Fi network you were connected to before resetting will be saved and the coatmaster® Flex will automatically connect to it.

i Even though it is possible to use a mobile phone to establish a connection to the cloud, it is recommended not to do so for the sake of connection stability, especially for mobile phones running under iOS.

7.7 Activation

When starting the device for the first time, or after a factory reset, with the device connected to the Internet (either with the provided router or via the selection of a Wi-Fi network), the licence number and the activation code must be entered to unlock your device. These details will have been sent separately to your Purchasing Department by email. If you are not prompted to enter the activation code and the coatmaster® Flex is working, we have already activated the device for you and no further action is required.

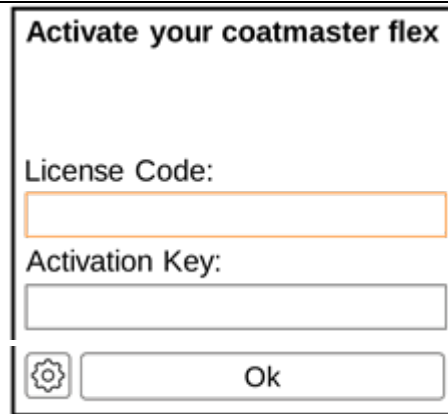

Figure 14: Activating menu

If you are prompted to enter the activation code, the cursor moves to the licence code field. When the OK button **Ⓒ** is pressed, a submenu opens, which contains a keyboard. Here the code can be entered, using the arrow keys **Ⓓ** to navigate the keyboard in conjunction with the OK button **Ⓒ** (see Figure 10: Input panel - keys and elements) to validate a character and move to the next one.

To save the licence code, use the arrow keys **Ⓓ** to move the cursor down to the 'Enter' field, then press the OK button **Ⓒ**. You can interrupt the operation at any time by moving the cursor to the 'Cancel' key and confirming with the OK button **Ⓒ**.

After saving the licence code, the submenu for the activation key will be opened. Proceed in a similar way to enter and save the activation key.

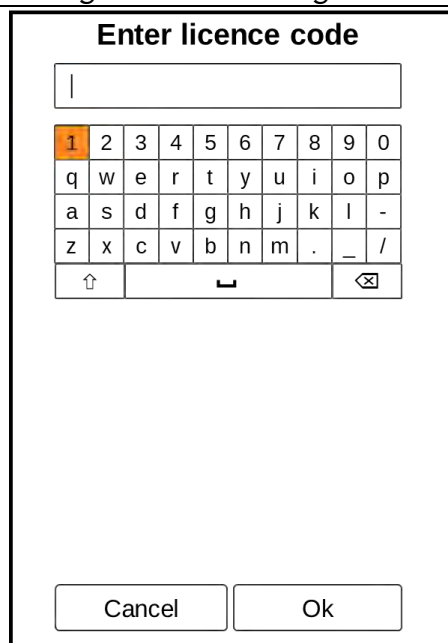

Figure 15: Submenu for licence codes

After the activation key is saved, you will be automatically redirected to the main menu (see Figure 24: Main display).

Your coatmaster® Flex is now properly set up. Before you can start measuring, you need to select the appropriate user level, the units in which you want to measure (metric or imperial), and the local time zone (see section 8.1).



8 Operating Instructions

The following steps guide you step-by-step through the individual process and menus. For the navigation in the following sections, the arrow keys and buttons of the input panel are used according to section 7.3 (Figure 10: Input panel - keys and elements).

8.1 System Settings

In the main menu, select the system settings icon by using the right arrow key ► twice and the OK button © to open the system settings menu.

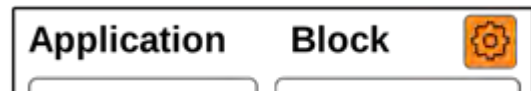

 <p>System Settings</p> <ul style="list-style-type: none"> Network Language Network Troubleshooter User level Timezone Measurement Unit Factory Reset 	<p>System settings contain the following categories:</p> <ul style="list-style-type: none"> • Network: to select and connect to a local Wi-Fi network (see 7.6). • Language: to change the language (see 7.5). • Network Troubleshooter: to perform a network diagnosis and obtain information on the Wi-Fi status (see 8.1.1). • User Level: to differentiate between the operational functionalities in the normal or advanced modes (see 8.1.2). • Time Zone: to select the local time zone, and control the time setting of the device (see 8.1.3). • Measurement Unit: to configure and display measurement results in micrometres (µm) or in mils. • Factory Reset: to return the system to the factory settings (see 8.1.5). <p>Choose the desired menu in the list, using the up/down arrow keys ▲▼ and the OK button © to validate.</p>
---	--

Figure 16: System settings menu

8.1.1 Network Troubleshooter

 <p>Troubleshooter</p> <p>Wifi connection status SSID: NETGEARip IP address: 192.168.1.166</p> <p>Internet connection status Online</p> <p>Cloud connection status Cloud connected Licence: XXXXXX-YY</p> <p>OK</p>	<p>Troubleshooter</p> <p>When activated, the system performs a network diagnosis. After a few seconds, the result of the network diagnosis will be shown in a report (see Figure 17: Troubleshooting).</p> <p>Colour coding:</p> <ul style="list-style-type: none"> • Green – functionality correct • Red – functionality not correct
---	--

Figure 17: Troubleshooting

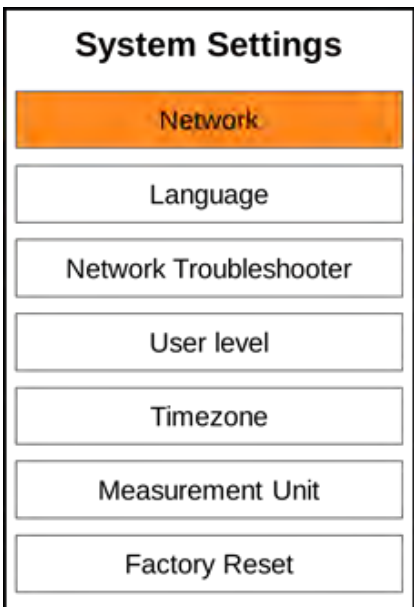
8.1.2 User Level



Figure 18: User level password



Figure 19: User level selection

The coatmaster Flex can be operated in two different User Level modes, the attributes of which are given in Table 5: User Levels. You can toggle between the different modes by selecting the User Level menu. When this setting option is selected for the first time, you will be directed to a keyboard window to enter your user level password. The Administrator password is **admino041**.

Enter the password, using the arrow keys **⬅** to navigate the keyboard, in conjunction with the OK button **Ⓞ** (see Figure 10: Input panel - keys and elements) to validate a character and move to the next one.

To validate the password, move the cursor down with the arrow keys and **⬇** into the 'Enter' field, then press the OK button **Ⓞ**. You can interrupt the operation at any time by moving the cursor to the 'Cancel' key and confirming with the OK button **Ⓞ**.

After validating the user level password, you must choose the user level (Standard/Admin). The default User Level is Admin. Once you have selected a user level, the level will be saved, even if you switch off your device.

Whenever you are switching from the Normal user level to the Admin user level, you must re-enter the password as described above.

After the user level selection, you will be directed back to the system settings.

User Level	Password protected	Measurement	Block Management	Application Management	Factory Reset
Standard	No	Measure	Add Select Rename	Select	No
Admin	Yes Password: admino041	Measure	Add Select Rename Delete	Add Select Rename Delete	Yes

Table 5: User level privileges

8.1.3 Time Zones

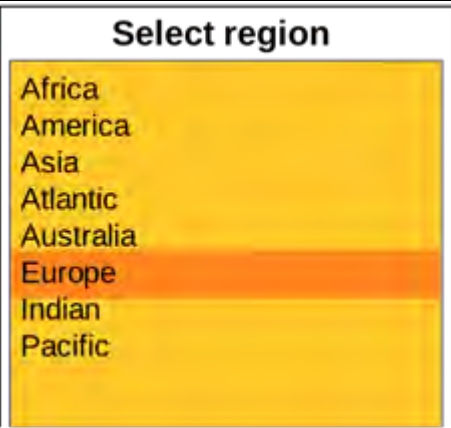
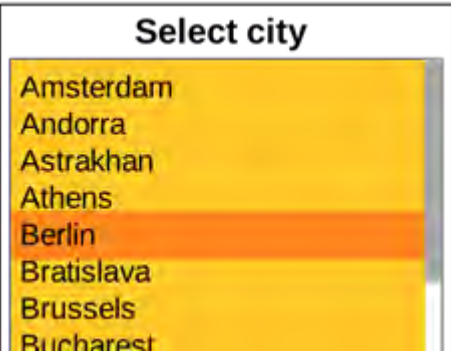
	<p>Time Zone</p> <p>When the time zone menu is activated, a new window opens to allow you to select the continental region.</p> <p>Use the up/down arrow keys ▼▲ Ⓓ to select the appropriate continent and the OK button Ⓒ to validate the region.</p> <p>When the continental region is set, a list of cities in the region is provided. Choose the nearest city to your location, using the up/down arrow keys ▼▲ Ⓓ and the OK button Ⓒ to validate the city. The grey scrolling bar (right edge of the screen) shows you the position in the list. The default time zone is Zurich.</p>
<p>Figure 20: Time zone – regions</p>	
	
<p>Figure 21: Time zone – cities</p>	

8.1.4 Measurement Unit

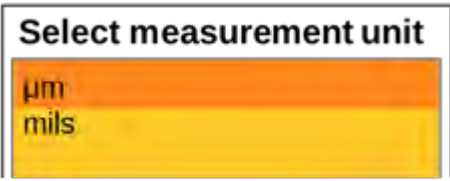
	<p>Measurement Unit</p> <p>To configure the displayed measurement units in micrometres (µm) or in mils, choose the desired unit using the up/down arrow keys ▼▲ Ⓓ and the OK button Ⓒ to validate the selection.</p>
<p>Figure 22: Select measurement unit</p>	

8.1.5 Factory Reset

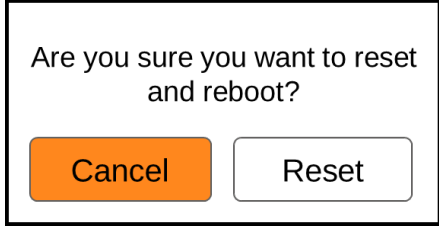
	<p>Factory Reset</p> <p>Allows you to reset the system to the factory settings. The factory reset will also reset the activation and will reboot the device!</p> <p>Select the 'Reset' field, using the left/right arrow keys ◀▶ Ⓓ and the OK button Ⓒ to reset the device to the factory settings and deactivate the licence. Alternatively, select the 'Cancel' field to return to the system settings menu.</p>
<p>Figure 23: Factory reset</p>	

i Only users using the Flex in Admin mode can do a Factory reset. For the Standard User Level this option is greyed out and cannot be activated.

8.2 Main Menu

The main menu, and descriptions of the elements of the coatmaster® Flex, are shown in Figure 24: Main display.

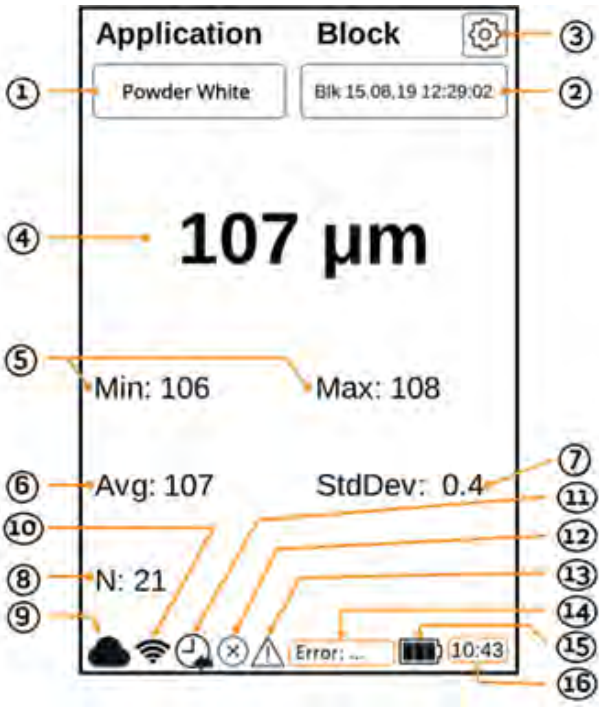

Main Menu

- ① Chosen application
- ② Chosen block
- ③ System settings
- ④ Measurement display
- ⑤ Measured value in selected unit (here, μm)
- ⑥ Statistics
- ⑦ Min. and max. values of the selected unit (here, μm)
- ⑧ Mean value in selected unit (here: μm)
- ⑨ Standard deviation in the selected unit (here: μm)
- ⑩ Measuring no.
- ⑪ Status line
- ⑫ Cloud status
- ⑬ WLAN signal level
- ⑭ Request for server
- ⑮ Error icon
- ⑯ Warn icon
- ⑰ Error-/Warning-/Status-message
- ⑱ Battery level
- ⑲ Time

Figure 24: Main display

The following options are available in the main menu

- a. **Access to the application menu**
Use the right arrow key \blacktriangleright ① and the OK button ② to select the application.
- b. **Access to the block menu**
Use the left arrow key \blacktriangleleft ③ and the OK button ② to select the block.
- c. **Triggering a measurement**
Press the Trigger button ④ (see Figure 4: Overview dimensions and components) to start a measurement.
- d. **Display trend chart**
Use the down arrow key \blacktriangledown ⑤ to display graphically the measured values in the trend chart. Use the up arrow key \blacktriangle ⑥ to return to the main menu.
- e. **System settings**
Use the right arrow key \blacktriangleright ⑦ twice, and the OK button ② to select system settings (see 8.1 System Settings).



Figure 25: Main menu





Use the back button ① to return to the main menu or to move one menu level up.

8.3 Block Menu

In the main menu use the left and right arrow keys ◀▶ⓓ to select the 'Block' field, and confirm with the OK button ⓐ according to section 7.3 (Figure 10: Input panel - keys and elements).

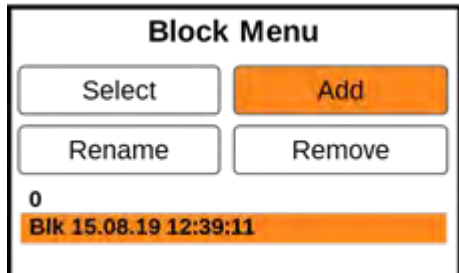
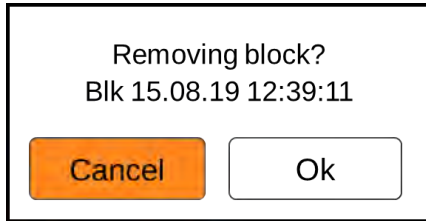

The block menu is accessible by all user levels, but with limited privileges for the Standard user level (see 8.1.2 User Level).

<p>Block saves different measurement series in separate directories. The statistics of the selected block are displayed in the main menu and in the trend chart. To activate one of the four fields ('Select', 'Add', 'Rename', or 'Remove') in the block menu, use the arrow keys ▲▼ⓓ and the OK button ⓐ from the input panel.</p> <p>If you choose 'Add' in the block menu, a new block with the current selected date and time will appear in the list.</p>	 <p>Figure 26: Block menu</p>
<p>If you choose 'Select' or 'Remove', the list with the available blocks will change colour to light orange and you can select the desired block using the up/down arrow keys ▼▲ⓓ and the OK button ⓐ from the input panel.</p> <p>To 'Remove' the desired block, you must confirm with 'OK'. To abort and return to the block menu, select 'Cancel'. (Use the arrow keys ▶◀ⓓ and the OK button ⓐ from the input panel).</p> <p>i Normal users cannot 'remove' blocks! This option is then greyed out and cannot be selected!</p>	 <p>Figure 27: Remove block</p>
<p>To edit a block, choose 'Rename' and select a block from the list. In the submenu you can rename the block by navigating the keyboard using the arrow keys ⓓ and entering the characters using the OK button ⓐ from the input panel. Select 'OK' to confirm the new block name. To abort and return to the block menu, select 'Cancel'.</p>	 <p>Figure 28: Rename block</p>

8.4 Application Menu

In the main menu, use the left and right arrow keys ◀▶Ⓓ to select the 'Application' field, and confirm with the OK button Ⓒ, according to section 7.3 (Figure 10: Input panel - keys and elements).



Normal users are only able to 'Select'

applications! Other options are greyed out and cannot be chosen! Admin users have access to all options (see section 8.1.2 User Level).

In the application menu, specific measurement parameters can be set. By using applications, these measurement parameters can be applied across a consistent set of measurements.

In the original state of the coatmaster® Flex, you will find five pre-set applications. They are displayed in bold.

- **Powder White** is a pre-set application for measuring white uncured powder.
- **Powder Non-White** is a pre-set application for measuring uncured powder with any colour except white.
- **Cured White** is a pre-set application for measuring cured white coating.
- **Cured Non-White** is a pre-set application for measuring cured coating of any colour except white.
- **Calibration standard** is a pre-set application for checking the calibration of your device with certified plates.



If you choose 'Select', the list with the available applications will change colour to light orange and you can select the desired application using the

up/down arrow keys ▼▲Ⓓ and the OK button Ⓒ from the input panel.

Lightning

discharge: when changing from a white application to a colour one, or vice versa, the flash generator in the coatmaster® Flex must discharge. A warning message is displayed and, when confirmed with 'Ok', a flash is immediately triggered.



Figure 29: Application menu

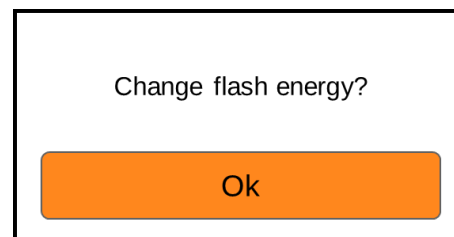

Figure 30: Flash energy change



WARNING (see section 5)

◊ Never look directly into the light source.



Greyed out applications written in italics cannot be selected and require further input, for which Admin level privileges are required. To complete such an application, it is necessary to perform at least one reference measurement with the corresponding layer thickness, as explained in the following section.

If you choose 'Remove', the list with the available applications will change colour to light orange and you can select the desired application using the up/down arrow keys ▼ ▲ Ⓓ and the OK button Ⓒ from the input panel. To remove the desired application, you must confirm with 'Yes'. To abort and return to the block menu, select 'Cancel' (using the arrow keys ► ◀ Ⓓ and the OK button Ⓒ from the input panel).

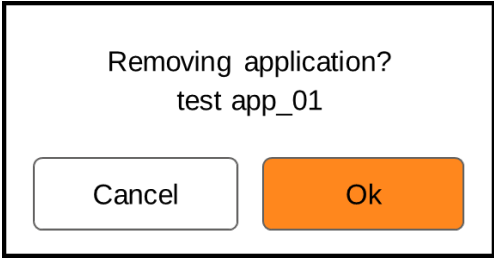

Figure 31: Removing an application



Pre-set applications written in bold letters can be neither removed nor edited, even in the Admin mode.

8.4.1 Calibration Menu

If the existing applications are not suitable for your use, you can 'Edit' an existing, or 'Add' a new, application (only in the Admin user mode). Selecting 'Edit' or 'Add' in the application menu will direct you to the calibration menu.

When selecting 'Edit', the list of available applications will change colour to light orange and you can select the desired application, using the up/down arrow keys ▼ ▲ Ⓓ and the OK button Ⓒ from the input panel. When you select 'Add', the application/calibration procedure is the same as for 'Edit', although a few fields may be blank. In the following keyboard screen (see Figure 32: Application name) you can edit and modify the application name, then confirm the name with 'Next' or abort your action with the back button Ⓑ. To fully quit the menu, 'Save' or 'Discard' your changes.



Figure 32: Application name

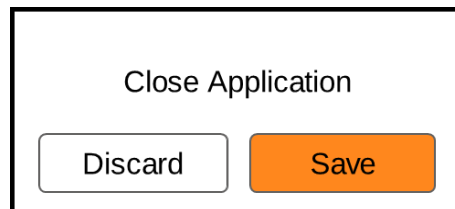

Figure 33: Close calibration

When you select 'Next', a new screen will appear (see Figure 34: Material Properties), which displays the calibration options that were initially chosen.

Use the up/down arrow keys ▼ ▲ (D) to navigate between the different fields and press the OK button (C) to open the corresponding drop-down menu. To select an option in the drop-down menu, proceed in the same way.

The 'Material properties' menu offers the following options:

- **Coating:** cured, powder uncured, wet uncured
- **Substrate:** metal, non-metal
- **Thickness range:** 0–50 µm; 20–200 µm; 100–500 µm; 200–1,000 µm
- **Colour:** white, non-white (any colour except white)



Figure 34: Material Properties



The colour option can only be set initially, when the application is newly created in the 'Add' mode. In the 'Edit' mode, the colour option is greyed out and cannot be changed.

After the material properties are defined, select 'Next' to set up the display options. The display options will configure your screen and the bounds in the trend chart (see Figure 36: Principle of Application Bounds). Bounds (limits) can be configured and optionally displayed for the

- Range (display limits of the chart)
- Error (quality tolerance)
- Warning (tolerance to initiate process changes)

To enable a bound, navigate with the up/down arrow keys ▼ ▲ (D) to the desired field and enable by pressing the OK button (C). The fields with lower and upper descriptions will appear in the display options screen.



It is essential that the bounds values are chosen according to the units selected in the Settings

menu (see Section 8.1.4 Measurement Unit)
Activate one of the bound fields by pressing the OK button (C)

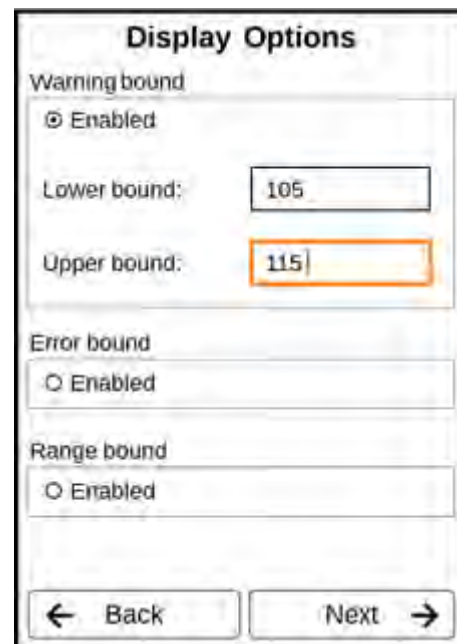

Figure 35: Display Options

To understand the relationship between the bounds in the trend chart, see Figure 36: Principles of Application Bounds and the Display Options in the Application menu (see Figure 37: Application Bounds).

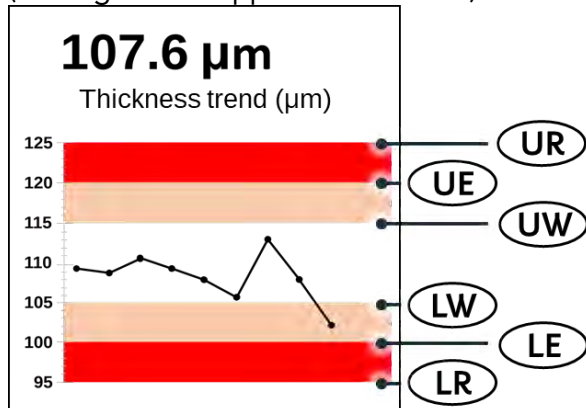

Figure 36: Principles of Application Bounds

- Measurement values inside the red bands of the chart are outside quality tolerance levels.
- Measurement values inside the yellow bands of the chart are in a warning zone, and corrective measures for the process must be taken.
- Measurement values inside the white bands of the chart are satisfactory. No measure is required.

Figure 37: Application Bounds

LW = Lower Warning UW = Upper Warning
 LE = Lower Error UE = Upper Error
 LR = Lower Range UR = Upper Range



The coating colour type determines the intensity of the flash. This means that a white sample generally requires more energy to achieve the desired temperature change on the surface. The coating colour type (i.e. White or Non-white) must be chosen before a reference measurement can be made.

In the 'Upper Bound' keyboard screen, you can enter the value of the bounds analogously with the up/down arrow keys ▼ ▲ and the OK button Ⓞ

Press the 'OK' button to validate the new bound value or select 'Cancel' to abort.



If the consistency of the bounds is not considered, or values are entered incorrectly, a red warning message will appear.

When you have established all your settings in the Display Options menu, select 'Next' to continue to the 'Calibration' screen, or select 'Back' to make changes to the material properties or edit the application name.

Figure 38: Bound setting

The screen in Figure 39: Calibration menu shows the different fields of the calibration menu:

- ① Application name
- ② Reference/calibration measurement(s)
- ③ 'Calibrate' (which starts the calibration process in the cloud).

Within the calibration menu, you can navigate up or down between the above-mentioned fields using the up/down arrow keys ▲ ▼ **D**.



Figure 39: Calibration menu

Now you can proceed to conduct a reference measurement to calibrate your device for this new application.

At this point, position your coatmaster® Flex approximately **5 cm** distant from the reference sample and press the trigger button **T** (see Figure 40: Reference/calibration measurement). A reference measurement will be taken, and this reference will be displayed, with a reference number, current date, and time, in the reference list (see Figure 41: References).



Figure 40: Reference/calibration measurement

If you select this new reference from the list **②**, using the OK button **C** from the input panel, a submenu will open, which enables you to edit the reference name and to enter the coating thickness of your reference measurement.

Alternatively, you can 'Save' the application and edit the reference name and thickness at a later stage.



Figure 41: References

In the submenu (see Figure 42: Edit Reference), use the arrow keys and **Ⓓ** to navigate the keyboard and the OK button **Ⓒ** to enter the characters in order to rename your reference or enter the coating thickness. Then click on 'OK' to assign this value to the selected reference.

'Cancel' returns you to the calibration menu. If you select 'Remove', you will be directed back to the calibration menu and the selected reference will be deleted from the reference list.



In order to make more accurate measurements with a single application, you are advised to make at least two reference measurements with two different layer thicknesses with the coatmaster® Flex. Trigger a reference measurement in the calibration menu by pressing the trigger button **Ⓓ** again.



Please be careful to enter the reference value in the units that were selected in the Settings Menu (see Section 8.1.4 Measurement Unit).

Measurements without a reference value are ignored in the calibration evaluation.

Once all settings for the new application are established, navigate with the arrow keys **Ⓓ** to the 'Calibrate' field **③** (see Figure 39: Calibration menu).

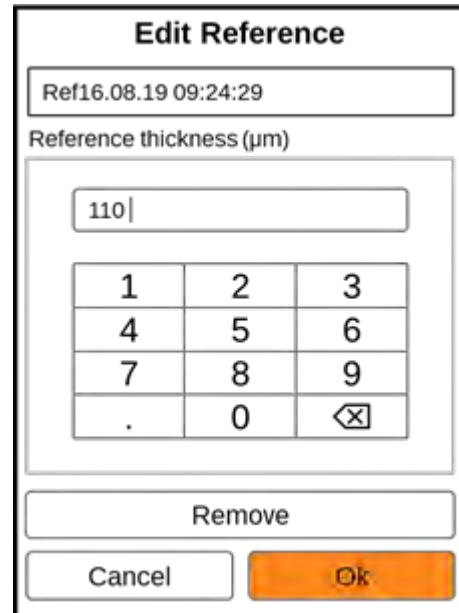

Figure 42: Edit Reference



A calibration report as shown in Figure 43: Calibration report will be generated by the coatmaster® Flex software.



The software will automatically check the results and will clearly display the status of the calibration process.

Select 'Close' to return to the main menu.

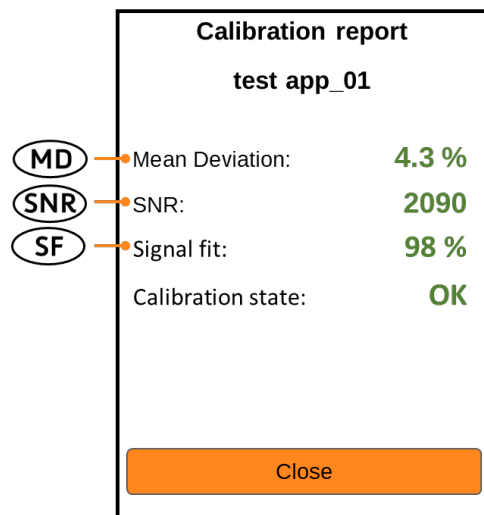

Figure 43: Calibration report

The calibration report provides an evaluation of the calibration performed. You will see the following values in the report:

- **MD (Mean Deviation of coatmaster® Flex from the reference value):**

The value should be less than 10%: the lower the value, the more accurate your measurement.

◇ If the value is greater than 10%, check the reference value.

- **SNR (Signal to Noise Ratio):**

The SNR value should be greater than 100: the higher the value, the less sensitive to perturbations your measurements will be.

◇ **If the value is less than 100**, move the measuring device closer to the surface and increase the light energy, if necessary.

- **SF (Signal Fit):**

The signal fit value should be greater than 90%.

◇ If the value is less than 90%, clean the optics with oil-free compressed air and repeat the calibration procedure. If the signal adjustment is still below 90%, please contact coatmaster AG's Technical Support hotline (contact details in section 9.4 Hotline)

The above values will be calculated and checked automatically by the coatmaster® Flex software after 'Calibrate' has been activated in the calibration menu.

8.4.2 Example of a Calibration Process



For further clarification of the calibration procedure, we describe the procedure using an example of a dark powder coating (RAL9005) on aluminium:

Step 1: Prepare three samples with coatings that are as different as possible; for instance:

Sample 1: 40–60 μm

Sample 2: 80–100 μm

Sample 3: 120–140 μm

Step 2: In the 'Application' menu, select 'Add', then type the name of the application 'ral9005' in the 'Application Name' submenu. Press 'Next' to move to the next submenu.

Step 3: In the 'Material properties' submenu, enter the appropriate material properties. In this case:

- **Coating:** Powder uncured
- **Substrate:** Metal
- **Thickness range:** 20–200 μm
- **Colour:** Non-white

then press 'Next'.

Step 4: In the 'Material properties' submenu, select the display options based on your quality management requirements. Press 'Next' to access the reference measurement submenu.

Step 5: Make a reference measurement for each sample with a dedicated measuring point. Note which reference measurement in the coatmaster® Flex calibration menu belongs to which reference sample and dedicated measuring point. If the coatmaster® Flex is required for another purpose, the dialogue box can be closed with 'Save'. The samples can now be burned in.

Step 6: After the samples have cooled down, make a measurement with another coating thickness at the points noted in step 4.

Step 7: If the calibration menu has been closed, select 'Edit' in the application menu and then 'ral9005'. Press 'Next' three times to access the reference measurement submenu. Now the values from step 5 can be entered for the respective reference measurements and you can complete the calibration by selecting 'Calibration'.



8.5 Measurement

When the dedicated application and block have been chosen and the calibration has been made, the measurement series for the coating samples can be performed.

Make sure that the appropriate application has been selected in the application menu (see section 8.4). Hold the coatmaster® Flex as steadily as possible at a distance of approximately **5 cm** from the sample (see Figure 44: Measurement). The measured surface is in the middle of the red circles and is approximately 2 mm² in diameter. The measurement process is started by pressing the trigger button **T**. When pressing the trigger button to conduct a measurement, a flash – comparable to a studio flash – is released.



WARNING

Please refer to the safety instructions in section 5.



Figure 44: Measurement

To display a trend chart for your measurements for the current block, use the down arrow key **▼** **D** in the input panel. (see section 7.3)

Use the up arrow key **▲** **D** to return to the previous main menu showing the numeric display.

The chart graphically shows the trend of the last 20 measurements for the selected block. If a measurement is outside the range bounds, it will not be displayed on the trend chart!

The vertical axis measurement values are displayed in the chosen units (see section 8.1.4).

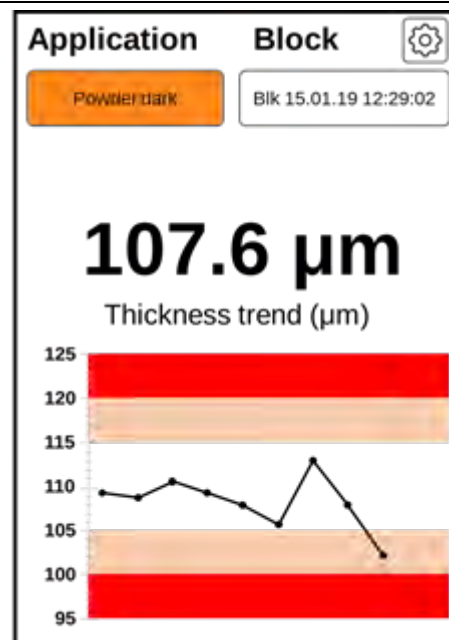

Figure 45: Trend chart



If the part to be measured is moving, keep up with the movement of the part, so that the relative movement between the part and the coatmaster® Flex is as small as possible, thus ensuring a stable measurement.



8.6 Data Transfer/Cloud

Now that you have made a set of measurements, you may want to process and further analyse the recorded data. This can be done by accessing the cloud server.

8.6.1 Cloud Login

Since all data is stored on a secure cloud server, you must log in to the coatmaster® cloud on your computer via the Internet to access the data.

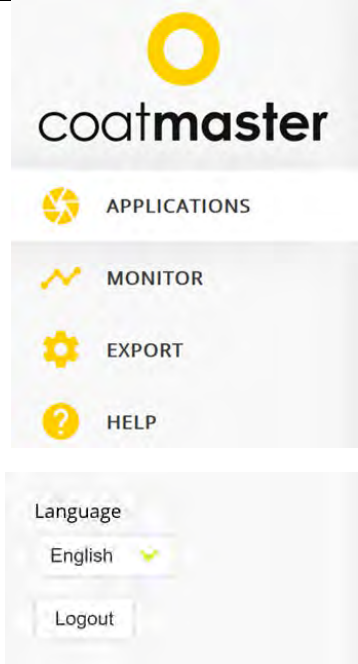
<p>Open https://coatmaster.cloud/ in your web browser.</p> <p>Login with the provided Username and Password (i.e. licence key and activation code). Validate your entries by clicking the Login button.</p>	 <p>Figure 46: Cloud login</p>
<p>You will automatically be directed to the home screen of the coatmaster® cloud website, which has four main menu buttons on the upper left side (Figure 47: Cloud main menu):</p> <ul style="list-style-type: none"> • Applications • Monitor • Export • Help <p>On the lower left side, you can choose the language (English, German, or French) or Logout.</p>	 <p>Figure 47: Cloud main menu</p>

8.6.2 Applications

The application menu in the coatmaster® cloud displays the available applications. The list provides details of the number of blocks and measurements per application.

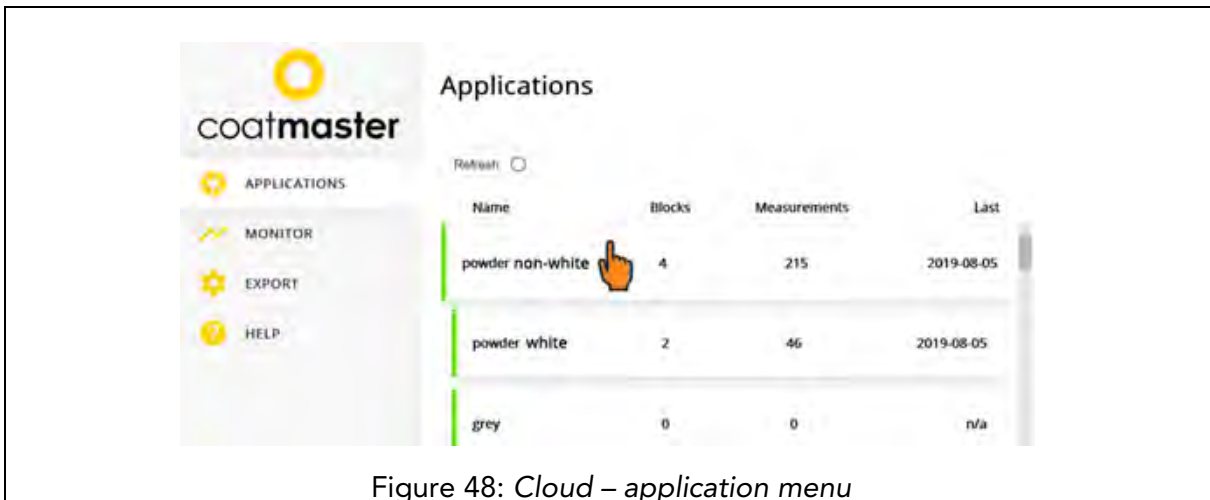

Figure 48: Cloud – application menu

To select an application, click on one of the applications in the list. You will automatically be directed to the monitor menu.

8.6.3 Monitor

Before you can monitor the trend chart of the application, which displays the measured thickness versus the time, you must select a block. Click on the block drop-down menu above the chart and select the desired block. To display the selected block, press the 'Refresh' button to reload the graph.

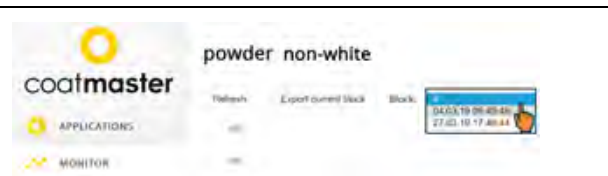
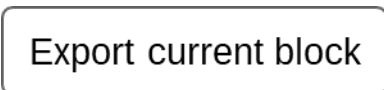

Figure 49: Cloud – monitor menu with block selection

To download the current block, simply click on



A prompting message will enable you to save or open the corresponding Excel file.

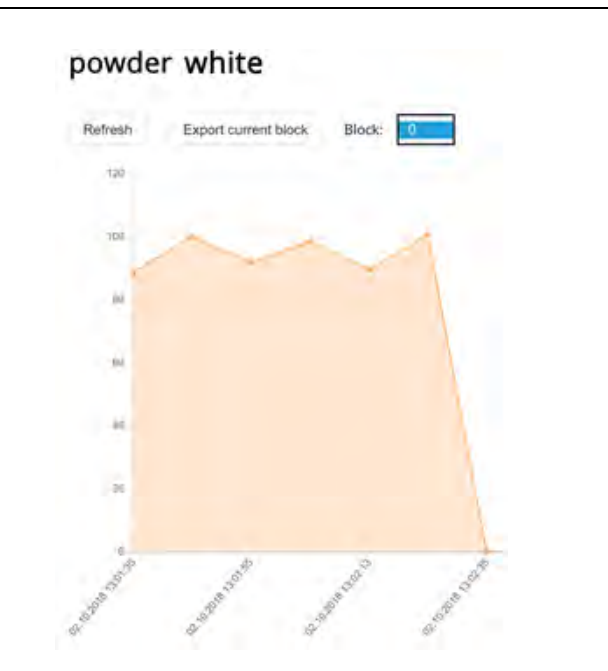

Figure 50: Cloud – monitor menu with chart

8.6.4 Export

Within the export menu of the coatmaster® cloud, you can select dedicated data and download it to your computer.



Figure 51: Cloud – export menu – select application

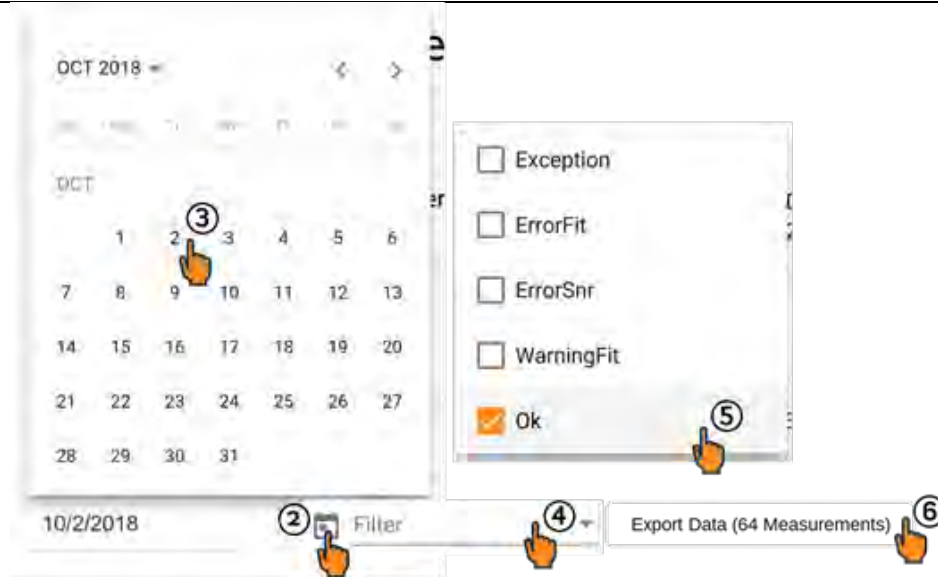

Figure 2: Cloud – export menu – limiting data select

① Click on the desired application.

The selected application will be copied to the export list in the right half of the window. You can remove the selected applications by clicking on the red cross (See Figure 52: Cloud – export menu – select application).

To limit your data selection, choose a start date for the data export. Click on the calendar icon ② and select the start date ③ in the calendar menu. You can also enter the start date in the corresponding field by using the format MM/DD/YYYY (MM = number of the month, DD = number of the day, YYYY = Year)

Additionally, you can apply one or more filters to select dedicated measuring data using ④ and ⑤.

Validate your selection and download the chosen data by clicking on the 'Export Data' button ⑥. A prompt message will enable you to save or open the corresponding Excel file.

8.6.5 Help

From the 'Help' menu, you can access further support information:

- User manual (in the selected language)
- Quick start guide (EN/DE)
- 'Contact Info' for technical support contact details
- Current error list

Help

[Download User Manual](#)

Technical support:

[+41 \(0\) 52 511 83 11](tel:+353525118311)

info@coatmaster.com

Figure 53: Help menu



9 Troubleshooting and Best Practice

9.1 Error Messages

Error Messages	Description ◇ Corrective measure
Cloud	Did not receive a response from the cloud. ◇ Check Internet status and perform a network diagnosis with 'Troubleshooter' (see section 8.1). ◇ Check the WLAN signal on the router. In the absence of a signal, reconnection of cables is required. If this is the case, reboot the router by switching the power plug off/on as necessary (see section 7). ◇ Check the status of your local Wi-Fi network.
Fit	Signal of sample does not match the application. ◇ Select appropriate application (see section 8.4). ◇ If the application was working previously, look for dirt on the lens or flash. For cleaning, see section 11.3.
SNR	Signal-to-noise ratio is too low. Either ◇ use an application with a higher flash power (see section 8.4) or ◇ move the device closer to the sample. For the measuring distance, see section 8.5.
Bounds	The measured thickness is outside the valid thickness limits set for the application. ◇ Sample does not meet the defined quality limits; set the appropriate quality limits (bounds). See section 8.4.

Table 6: Error messages and corrective measures

9.2 Error Codes

Technical Errors	Description ◇ Corrective measure
0	Received an 'Error' message from the cloud when measuring. ◇ Check the Internet status and perform a network diagnosis with 'Troubleshooter' (see section 8.1).
1	Wrong parameter. ◇ Contact coatmaster AG for further assistance.
2	No data acquisition (DAQ) board. ◇ Contact coatmaster AG for further assistance.
3	Data acquisition (DAQ) busy. ◇ Contact coatmaster AG for further assistance.
4	Flash generator timeout. ◇ Contact coatmaster AG for further assistance.
5	Data acquisition (DAQ) error. ◇ Contact coatmaster AG for further assistance.
6	Raw data process error ◇ Contact coatmaster AG for further assistance
7	No light pulse detected. ◇ Check whether you have selected the right energy level for your application (see Section 8.4 Application menu). ◇ Contact coatmaster AG for further assistance.
8	Wrong light pulse timing. ◇ Contact coatmaster AG for further assistance.
9	Cannot open file. ◇ Contact coatmaster AG for further assistance.
10	Cloud timeout. ◇ Check your Wi-Fi settings. ◇ Check the internet status and perform a network diagnosis with 'Troubleshooter' (see section 8.1). ◇ Contact coatmaster AG for further assistance.
11	Wrong message format. ◇ Contact coatmaster AG for further assistance.
12	Http error. ◇ Contact coatmaster AG for further assistance.
13	Unknown error. ◇ Contact coatmaster AG for further assistance.
14	Unable to connect to Wi-Fi. ◇ Check your Wi-Fi settings. ◇ Check the internet status and perform a network diagnosis with 'Troubleshooter' (see section 8.1). ◇ Contact coatmaster AG for further assistance.
15	IR signal clipping: ◇ Use a lower flash energy (that is in the case you are using White for colour), select non-white for your application ◇ If you measure on hot pieces, try to wait till the parts cool down ◇ Contact coatmaster AG for further assistance
16	Photodetector signal clipping: ◇ Contact coatmaster AG for further assistance
17	Wrong acquisition parameter: ◇ Contact coatmaster AG for further assistance

Table 7: Error codes and corrective measures

For further information please contact coatmaster AG's Technical Support (for contact details, see section 9.4).

9.3 Frequently Asked Questions (FAQs)

Keyword	Description
	<ul style="list-style-type: none"> • Reason ◊ Corrective measure
Do not start	<p>My coatmaster® Flex does not turn on.</p> <ul style="list-style-type: none"> • Battery almost empty. ◊ Recharge battery.
Sudden shut-down	<p>My coatmaster® Flex immediately shuts down after triggering a flash.</p> <ul style="list-style-type: none"> • If it happens rarely, ◊ leave it and restart the device. • If it happens regularly, ◊ return it to coatmaster AG for repair.
Fan not running	<p>The fan of my coatmaster® Flex is not running.</p> <ul style="list-style-type: none"> • Measurements will become unstable. ◊ Send the device back to coatmaster AG for repair.
Sudden flash without trigger	<p>coatmaster® Flex triggers a flash or multiple flashes without pressing the trigger button.</p> <ul style="list-style-type: none"> • Strong magnetic field (i.e. spark of powder coating gun).
Unstable results	<p>Unstable measurements or varying thickness values when using the coatmaster® Flex.</p> <ul style="list-style-type: none"> • coatmaster® Flex is too hot. ◊ Search for a cooler measuring environment, allow the coatmaster® Flex to cool down, and never leave the coatmaster® Flex in direct sunlight for an extended period of time. • Parts to be measured are too far away. ◊ Follow the instructions regarding sample distance in section 8.5. • Wrong flash intensity selected. ◊ Select the appropriate colour in the calibration menu (see section 8.4).

9.4 Hotline

Technical Support for coatmaster® Flex



Watch our detailed video instructions on www.YouTube.com
Keyword: '**coatmaster Flex**'



+41 (0) 52 511 83 11



info@coatmaster.com



10 Storage and Transportation

To ensure that your coatmaster® Flex is always protected from dust, dirt, moisture and damage, always store the measurement device, router, and batteries safely in the transport case when not in use.

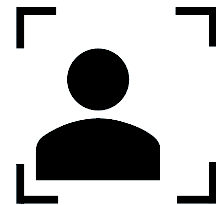

11 Maintenance and Repair

For any repair or service of the device, excluding light maintenance, please send the coatmaster® Flex back to the manufacturer (coatmaster AG).

Light maintenance: coatmaster® Flex needs to be inspected, at least weekly, for inlet filter cleanliness, and front glass transparency and cleanliness. A set of spare inlet filters and a front glass are provided with your coatmaster® Flex.

For larger quantities, inlet filters and front glass components are available for order online through flex.coatmaster.com.

In case of any other tampering, or opening of the device, the warranty will immediately be terminated.

Table 9 gives you an overview of the items that need to be regularly maintained on your coatmaster® Flex

Item	Description Level	Maintenance Level	Done by
Inlet filter	Regular maintenance	L1	User
Outlet filter	Extraordinary maintenance	L2	coatmaster AG
Front glass	Regular maintenance	L1	User
Battery	Regular maintenance	L1	User
Flash lamp	Extraordinary maintenance	L2	coatmaster AG

Table 9: Items to be maintained and maintenance level

Maintenance Level:

Level 1: can be done by the user of the coatmaster® Flex.

Level 2: must only to be done by a coatmaster AG Technician.

Level 2 maintenance by the user, or any technician except an authorised coatmaster AG, technician, is prohibited. In such a case, the warranty will immediately be terminated.

11.1 Replacement of the Inlet Filter

The inlet filter must be inspected, at least weekly, by the user of the coatmaster® Flex to avoid a malfunction of the device. If it is dirty, change the filter; otherwise, change the filter every second week or after 80 hours of use, whichever is earlier.

<p>Remove the bottom cover to examine the inlet filter of the coatmaster® Flex. The filter should be clean, as shown in Figure 54: Inlet filter replacement. If the inlet filter is dirty, please exchange the inlet filter for the one that has been provided with your delivery.</p> <p> Never reposition a reversed dirty filter in the filter holder, since this will blow dust inside the coatmaster® and damage the device. Always use a clean, new filter.</p>	 <p>Figure 54: Inlet filter replacement</p>
<p>Make sure that the filter is well positioned by pushing it toward the handle before closing the cover. The filter should cover the entire grid surface and no space should be visible after closing the filter cover, as shown in Figure 55: Positioning of the inlet filter.</p>	 <p> <i>Wrong</i>  <i>Correct</i></p> <p>Figure 55: Positioning of the inlet filter</p>
<p> Never attempt to clean the inlet and outlet filters with compressed air, since this will blow the dust particles inside the coatmaster® Flex and possibly push the filters away from their correct position.</p>	

11.2 Replacement of the Front Glass

The front glass must be replaced using the tools provided in your coatmaster Flex case.

Change the front glass by removing the four screws on the front of the coatmaster® Flex, using the tool provided. After removing the aluminium ring, you will be able to change the front glass.

After replacing the front glass, screw the front ring to the coatmaster® Flex head, using the tool provided.



Figure 56: Front glass replacement

11.3 Cleaning and Care



After cooling, clean the coatmaster® Flex with clean, dry, lint-free paper cloths. Never clean the front glass or the lens with alcohol-based cleaners!
Do not clean the device with compressed air!

11.4 Warranty

Your coatmaster® Flex is covered by a one-year warranty.

Winterthur, September 2019